

# CARLO RAIMONDI



Tower Crane

## City Crane MR75

Luffing Jib Crane

### MR75

Gru molto versatile con un design all'avanguardia. Vero esempio di tecnologia avanzata, è realizzata con materiali strutturali di alto livello per ottenere il massimo in semplicità, efficienza ed affidabilità. Dispone di un braccio da 48 metri, facile da montare, ideale per operare al meglio anche in centri urbani.

### MR75

*Very versatile crane with an advanced design. Real paragon of advanced technology, this crane is manufactured with high-level structural materials to ensure the highest efficiency and reliability levels. It is equipped with a 48 m. jib, very easy to be assembled, ideal for operation in urban areas too.*



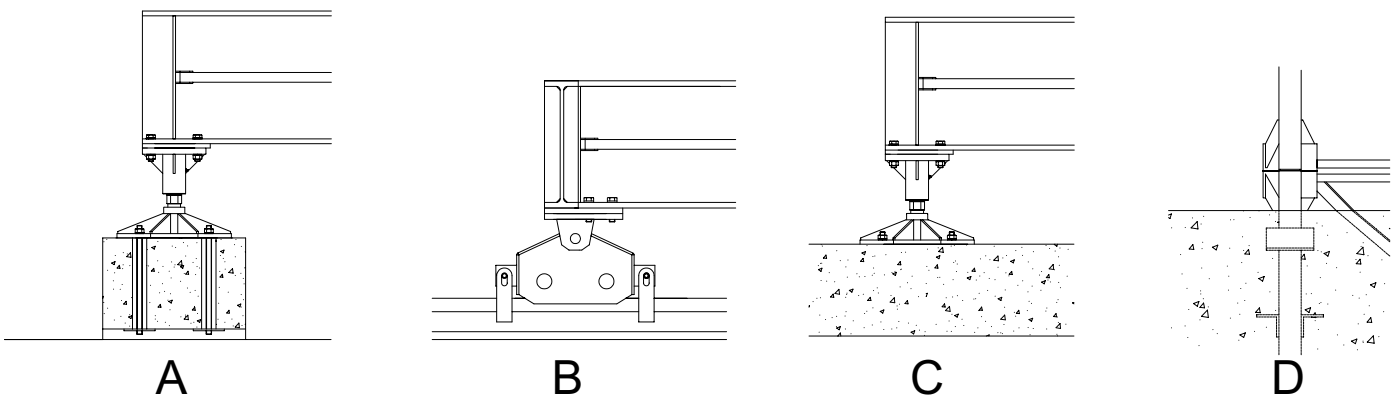
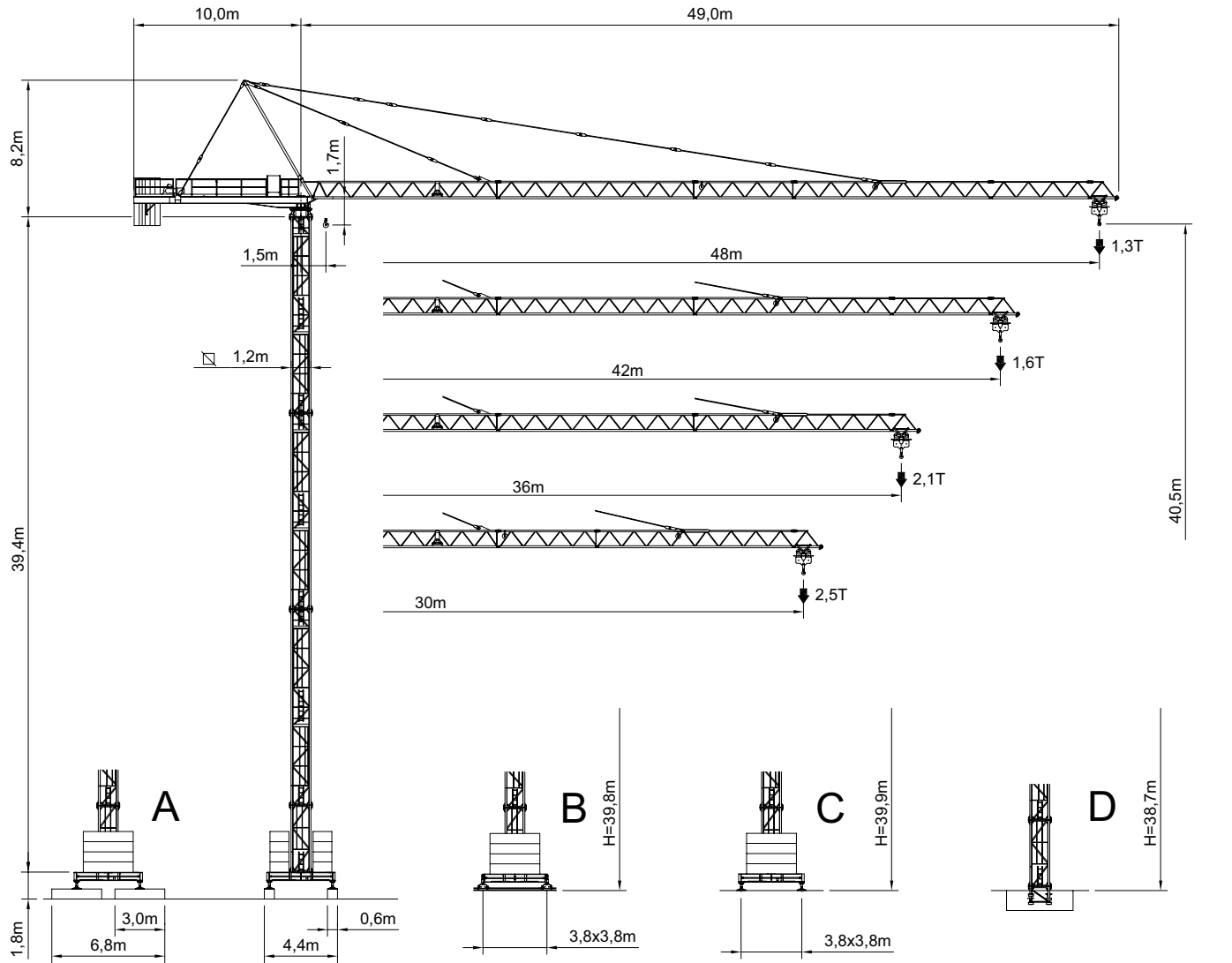

# City Crane MR 75E

GRU A TORRE A MONTAGGIO RAPIDO  
«CITY TOWER CRANE»



H1 B3 DIN151018 / A4 FEM1,001

RAGGI E PORTATE  
RADIUS AND S.W.L.  
PORTEE ET CHARGE UTILE  
AUSLADUNG UND TRAGFAHIGKEIT

Portata max / Max s.w.l. Charge maxi / Max. Tragfähigkeit		2500 kg. 				3000 kg. 				5000Kg   / 2500 kg. 			
Braccio / Jib Ausleger / Flèche	m.	30	36	42	48	30	36	42	48	30	36	42	48
Campo di portata max da Max s.w.l. range from Charge maxi de Max. Tragfähigkeit von	1,5 m a to à bis	30	30	28	27	28,2	26,2	24,2	23,2	17,6	16,5	15,4	14,9
Raggi (m.) Radii (m.) Portée (m.) Ausladung (m.)	12	2500	2500	2500	2500	3000	3000	3000	3000	5000	5000	5000	5000
	14	2500	2500	2500	2500	3000	3000	3000	3000	5000	5000	5000	5000
	16	2500	2500	2500	2500	3000	3000	3000	3000	5000	5000	4770	4600
	18	2500	2500	2500	2500	3000	3000	3000	3000	4870	4520	4170	4020
	20	2500	2500	2500	2500	3000	3000	3000	3000	4320	4010	3700	3560
	22	2500	2500	2500	2500	3000	3000	3000	3000	3870	3590	3310	3190
	24	2500	2500	2500	2500	3000	3000	3000	2890	3500	3250	2990	2880
	26	2500	2500	2500	2500	3000	3000	2765	2640	3190	2960	2720	2610
	28	2500	2500	2500	2431	3000	2787	2545	2430	2930	2710	2490	2390
	30	2500	2500	2355	2249	2800	2580	2355	2250	2700	2500	2290	2200
	32		2400	2189	2090		2400	2190	2090		2310	2120	2030
	34		2241	2043	1949		2240	2040	1950		2150	1960	1880
	36		2100	1914	1825		2100	1910	1825		2000	1830	1750
	38			1798	1714			1800	1710			1710	1640
	40			1694	1614			1690	1610			1600	1530
	42			1600	1524			1600	1520			1500	1440
44				1443				1440				1350	
46				1368				1370				1270	
48				1300				1300				1200	

BRACCIO E CONTRAPPESO  
JIB AND COUNTERWEIGHT  
FLECHE ET CONTREPOID  
AUSLEGER UND GEGENGEWICHTSBALLAST

Braccio / Jib Flèche / Ausleger	(m)	30	36	42	48
Contrappeso / Counterweight Contrepoid / Gegengewicht	(t)	6,612	7,934	9,256	11,460
Composizione Composition Komposition	Tipo / Type	Quantità / Quantity / Nombre / Anzahl			
	A75	3	3	3	4
	B75	-	1	2	2

ALTEZZA SOTTO-GANCIO, ZAVORRA DI BASE, REAZIONI  
 H.U.H., MAX. BASE BALLAST AND CORNER PRESSURE  
 H.S.C., LEST DE BASE MAXI ET REACTIONS  
 HAKENHOHEN, MAXIMALE ZENTRALBALLASTE UND ECKKRAFT

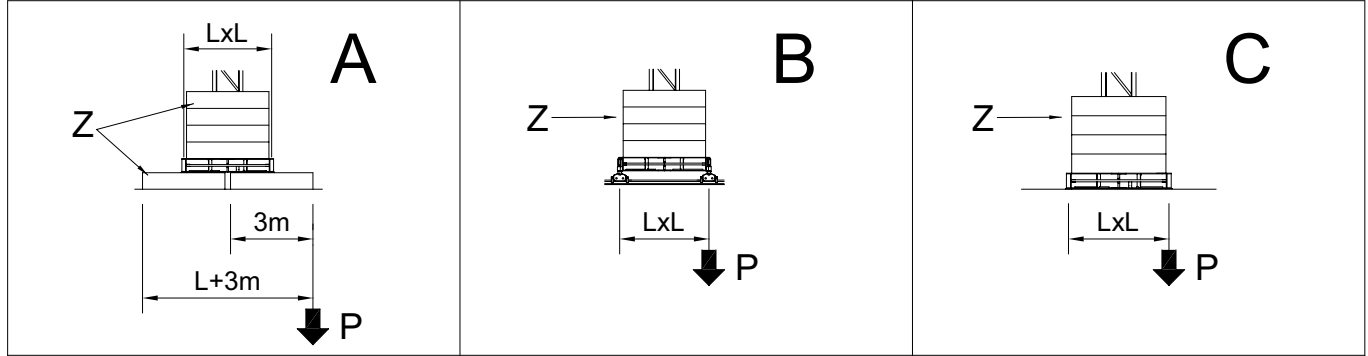





SU BASE / ON CROSSBASE SUR CHASSIS / AUF KREUZRAHME								
L = 3,8 m (□ 1,2m)								
H (m)	max. Z (t)	P (kN)	H (m)	max. Z (t)	P (kN)	H (m)	max. Z (t)	P (kN)
40,7	49,5	569	40,4	49,5	561	40,2	49,5	556
36,7	49,5	454	36,4	49,5	447	36,2	49,5	442
30,7	49,5	358	30,4	49,5	359	30,2	49,5	357
24,7	39,6	311	24,4	39,6	313	24,2	39,6	310
18,7	39,6	292	18,4	39,6	294	18,2	39,6	291

SU BASE / ON CROSSBASE SUR CHASSIS / AUF KREUZRAHME								
L = 3,8 m (□ 1,18m)								
H (m)	max. Z (t)	P (kN)	H (m)	max. Z (t)	P (kN)	H (m)	max. Z (t)	P (kN)
36,0	49,5	531	35,8	49,5	525	35,4	49,5	513
30,1	49,5	371	29,9	49,5	373	29,5	49,5	369
24,2	39,6	319	24,0	39,6	322	23,6	39,6	318
18,3	39,6	297	18,1	39,6	299	17,7	39,6	296

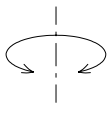
SU PLINTO / STATIONARY  
 SUR PIEDS DE SCELLEMENT / STATIONAR

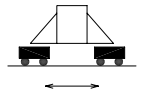
	H (m)	17,0	22,9	28,8	34,7		H (m)	11,6	17,6	23,6	29,6	35,6	39,6
	T (kN)	464	526	606	916		T (kN)	373	418	473	542	661	856
	P (kN)	588	661	752	1089		P (kN)	479	531	594	670	812	1013
	q max. (Kg/cm <sup>2</sup> )	1,127	1,264	1,454	2,689		q max. (Kg/cm <sup>2</sup> )	0,825	0,89	0,973	1,083	1,372	1,856

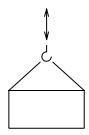









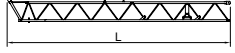

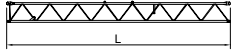

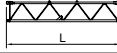

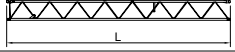

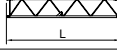





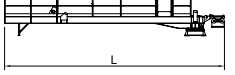



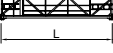





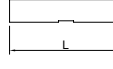

		Velocità / Speed / Vitesse / Geschwindigkeit	Potenza / Power / Puissance / Leistung
Rotazione Slewing Orientation Schwenken		0,3 / 0,6 / 0,9 min <sup>-1</sup>	4,0 Kw
Carrello Trolley Chariot Katzfahren		28,5 / 57 m/min	1,1/2,2Kw
Traslazione Rail Translation Kranfahren		14 m/min	2 x 2,9 Kw

Argano Winch Treuril Hubwerk		Marcia Step Vitesse Gang	Carico / velocità - Load / speed Charge / vitesse - Tragfähigkeit / Geschwindigkeit	
				
Tipo Type Type Typ	15 HP 11 Kw - 2,5	1	2500 Kg - 5,2 m/min	-
		2	2500 Kg - 21 m/min	-
		3	1250 Kg - 42 m/min	-
	25 HP 18,4 Kw - 3	1	3000 Kg - 7,5 m/min	-
		2	3000 Kg - 30 m/min	-
		3	1500 Kg - 60 m/min	-
	25 HP 18,4 Kw - 5	1	2500 Kg - 8,8 m/min	5000 Kg - 4,4 m/min
		2	2500 Kg - 35 m/min	5000 Kg - 17,5 m/min
		3	1250 Kg - 70 m/min	2500 Kg - 35 m/min

Conforme alla direttiva CEE 85/534 sul livello acustico - In compliance with the EEC 84/534 instruction on noise level - Conforme à directive CEE 84/534 sur le niveau acoustique  
Gemäss EWG 84/534 über Schall - Leistungspegel - Conforme con la direttiva CEE 84/534 sobre el nivel acustico.

FORZA MOTRICE TOTALE TOTAL INSTALLED POWER PUISSANCE TOTALE DES MOTEURS GESAMT-MOTORENLEISTUNG	11 Kw (15HP)	18,4 Kw (25HP)
	23 Kw	31 Kw

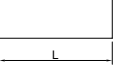
LISTA DEI PESI / PACKING LIST  
LISTE DE COLISAGE / KOLLI-LISTE

Pos. Item	Pezzi Pieces	Denominazione Description	Schizzo Sketch	Dimensioni Dimensions			Peso Weight (Kg)		
				L	W	H	Unit.	Total.	
1	1	<b>Elemento di freccia</b> Jib element Elément de flèche Ausleger	N°1 		12,005	1,100	1,295	920	920
	1		N°2 		11,985	1,100	1,100	790	790
	1		N°3 		6,100	1,100	1,100	405	405
	1		N°4 		12,000	1,100	1,100	845	845
	1		N°5 		6,160	1,100	1,100	366	366
	1		N°6 		1,880	1,100	1,200	118	118
2	1	<b>Cuspide</b> A frame Pointe Turmspitze			6,900	0,400	0,950	495	495
3	1	<b>Controfreccia girevole, argano sollev., quadro elettrico, carrello freccia.</b> Counterjib-turnstile, hoisting winch, trolley jib, electrical box. Contreflèche tournante, treuil de levage, chariot de flèche, armoire électrique. Gegenausleger, Hubwinde, Drehwerk Laufkatze, Schaltschrank.			11,970	1,540	2,500	5210	5210
4	4	<b>Blocchi di contrappeso</b> Counterweight block Contre-poids Gegengewichtsbloecke		A75 	1,250	0,300	2,865	2204	8816
	2			B75 	1,250	0,180	2,865	1322	2644
5	1	<b>Elemento di torre</b> Tower element Elément de mature Turmstück			5,900	1,200	1,380	1515	1515
					11,800	1,200	1,380	2830	2830
6	1	<b>Tronchetto di fondazione</b> Expendable foundation element Elément a sceller Fundamentanker			1,090	1,200	1,380	485	485
7	1	<b>Trave principale della crociera di base</b> Base main beam Poutre de chassis de base Hauptträger für Kreuzgelenk			5,720	0,670	0,650	1560	1560
8	2	<b>Semitrave della crociera di base</b> Half base beam Semipoutre de chassis de base Halbträger für Kreuzgelenk			2,770	0,450	0,665	750	1500
9	4	<b>Blocco di appoggio</b> Concrete pad Sabot en béton Betonfuss			3,000	0,600	0,600	2465	9860
10	2	<b>Bilancino traslazione folle</b> Driven bogie Boggie fou Fahrschemel ohne motorantrieb			0,800	0,195	0,385	190	380
11	2	<b>Bilancino traslazione motorizzato</b> Driving bogie Boggie motorisée Fahrschemel mit motorantrieb			0,925	0,425	0,385	310	620
12	10	<b>Blocco di zavorra</b> Base ballast block Lest de base Grundballastblöcken			3,000	1,200	0,600	4953	49530

SEQUENZA DI MONTAGGIO  
ASSEMBLING SEQUENCE  
SEQUENCE DE MONTAGE  
AUFSTELLUNG SEQUENZ

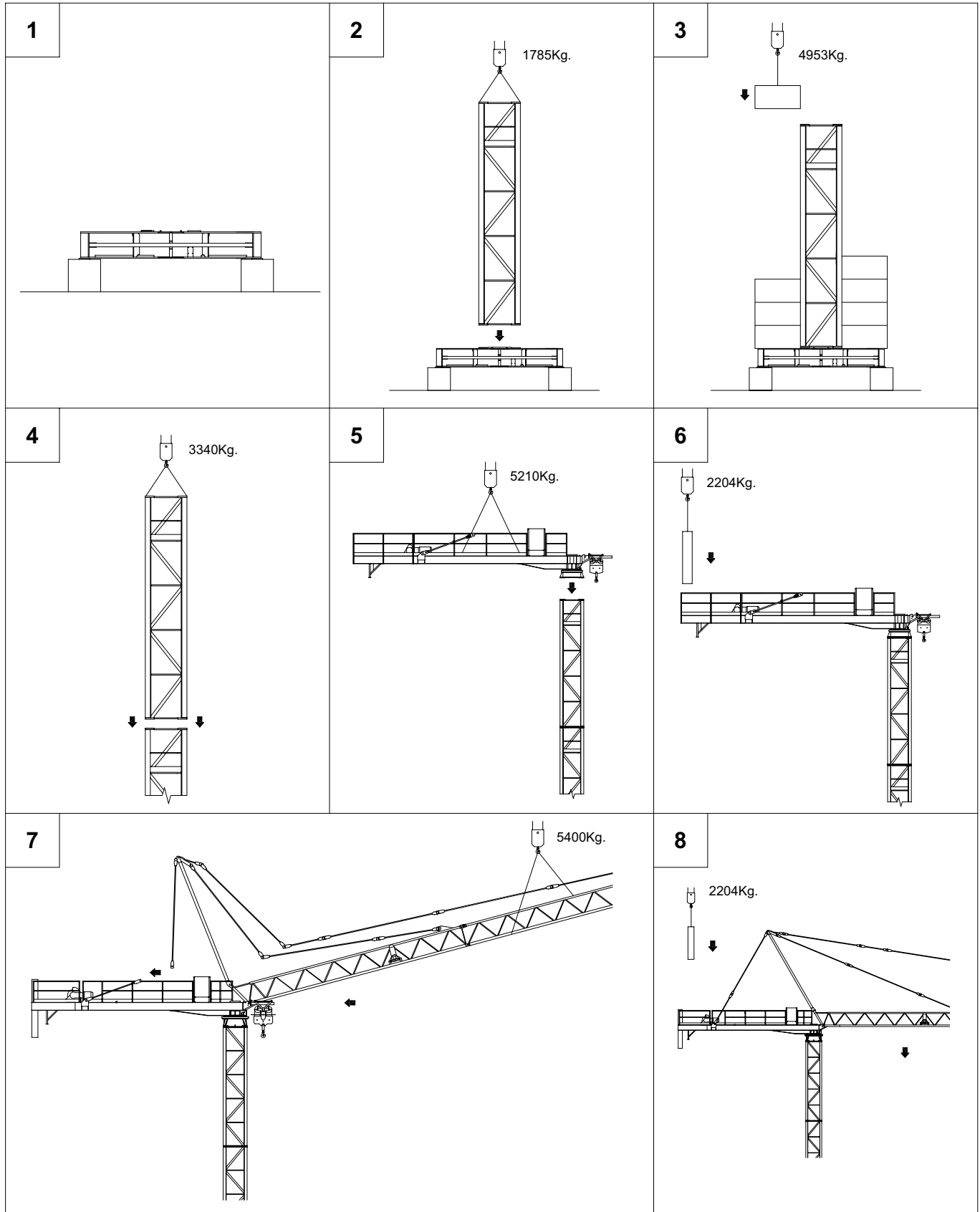

# MR 75HC

A SOPRALZO IDRAULICO  
EXTERNAL CLIMBING  
TELESCOPABLE  
KLETTERKRANE

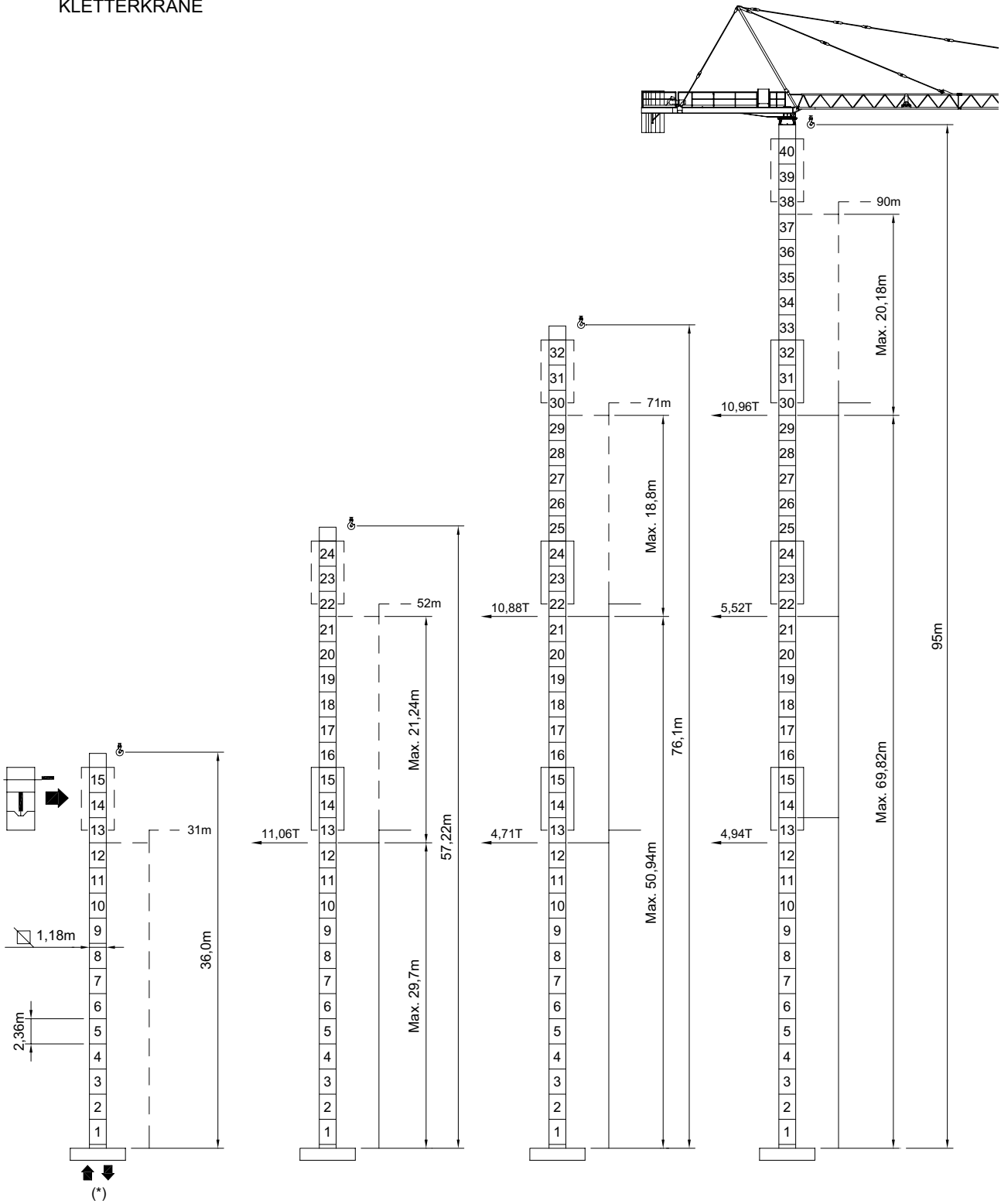

\* Vedi tabella a pag. 4 - See table at page 4 - Voir table à la page 4 - Siehe tafel an seite 4

# CARLO RAIMONDI S.p.A

Gru a torre per l'edilizia  
Building tower cranes  
Grues tour  
Turmdrehkrane



Stabilimento:  
Corso Garibaldi 253 - 20025 Legnano (MI) - ITALY - Fax: 0331450400 - Tel. 0331548061 - 0331545308 - www.raimondigru.it